

**1.6M X 2.4M GARDEN SHED
ASSEMBLY INSTRUCTIONS EZ-16242**



Congratulations on purchasing your new proudly South African **eazished**. Before commencing the assembly, we recommend that you read the instructions thoroughly. Your new shed comes with holes pre drilled to make for fast, easy assembly. We recommend that you assemble the shed using a trestle table or sawhorses and planks. This will ensure that you are working off the ground and make it easier for you. Assembly is a two person job and should not be attempted in windy conditions. Please study this manual carefully and follow the instructions to avoid mistakes.

ASSEMBLY IN 7 EAZI STEPS

- Step 1: Check all parts against the component list
- Step 2: Pre-assemble rear and side wall panels
- Step 3: Pre-assemble front panel & door
- Step 4: Pre-assemble roof
- Step 5: Lay pre-assembled panels out in open space
- Step 6: Erect pre-assembled wall panels
- Step 7: Attach the roof

TOOLS REQUIRED



Spirit Level



Cordless Drill or one with long lead



Sturdy Ladder (two If possible)

OPTIONAL



Measuring Tape



Pop Rivet Gun



Rubber Mallet

SITE PREPARATION

Make sure your site is level and free of obstructions.

We recommend anchoring your shed to a 100mm thick cured concrete slab or similar base structure with an anchor kit (see page 11 for base instructions).

A NOTE ON SAFETY

This product will have some sharp edges. We recommend both safety gloves and goggles when handling items and drilling holes.

Ensure shed is securely anchored to base concrete slab once you have completed the build.

A minimum of 2 people are required to erect the shed.



Gloves







Goggles



Saw horse



CONTENTS OF FASTENING KIT



| Picture | Component | Qty | Picture | Component | Qty |
|---|---------------------------|-----|---|---------------------|-----|
|  | Wafer C2 screws (14x10mm) | 160 |  | Pad bolt and keeper | 1 |
|  | 4.8x12mm rivet | 10 |  | Ph2 bit | 2 |

STEP 1: Check all parts against the component list. Lay out all parts with number facing outwards and check off against parts list.

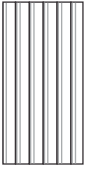
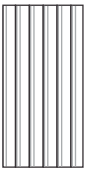
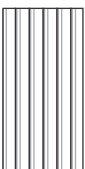

Side / Back Walls Module

| Part No. | Picture | Description | Component | location | QTY | Check |
|----------|--|-------------|---|-------------------|-----|-------|
| 1 |  | Sheet | Sheet 1785x900 left edge bent at right angle with pre-drilled holes | Side / back walls | 3 | |
| 18 |  | Sheet | Sheet 1785x900 with pre-drilled holes | Side walls | 2 | |
| 2 |  | Sheet | Sheet 1785x900 left edge bent at right angle | Side / back walls | 3 | |



Front Wall Module

| | | | | | | |
|---|---|-------|--|---------------------------|---|--|
| 4 |  | Sheet | Sheet 1785x140 right edge bent at right angle Inner lip bent at 10mm | Front wall | 2 | |
| 5 |  | Sheet | Sheet 1735 x 685 both edges bent at right angle | Front wall DOOR MODULE | 2 | |





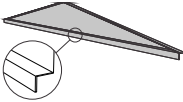
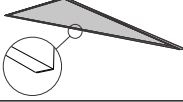
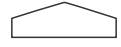



Roof Module

| Part No. | Picture | Description | Component | location | QTY | Check |
|----------|---|-------------|--|----------|-----|-------|
| 6 |  | Sheet | Sheet 920x900 bent at right angle, edges(rounded) with pre-drilled holes | Roof | 2 | |
| 19 |  | Sheet | Sheet 920x900 with pre-drilled holes | Roof | 2 | |
| 7 |  | Sheet | Sheet 920x900 bent at right angle, edges(rounded) | Roof | 2 | |

Roof Module

| Part No. | Picture | Description | Component | location | QTY | Check |
|----------|---|-------------|-------------------------------------|--------------|-----|-------|
| 8 |  | Gable | Sheet 1690 with top edges bent over | Front / rear | 2 | |
| 25 |  | Gable | Sheet 1690 with top edges bent over | Inside shed | 2 | |
| 9 |  | Cover Plate | Green Gable apex cover | Front / rear | 2 | |
| 10 |  | Cap | Ridge cap 2405 | Roof | 1 | |

Channeling Module

| Part No. | Picture | Description | Component | location | QTY | Check |
|----------|---|---------------|-----------------------------------|------------------------------|-----|-------|
| 11 |  | Cut U Channel | Door inner 1790 left & right side | Inside door channel | 2 | |
| 13 |  | Channel | Channel top/bottom 1665 | Rear wall edges | 2 | |
| 15 |  | U Channel | U-channel 1665 bottom/top | Front wall channel | 2 | |
| 20 |  | U Channel | Door inner 1385 bottom/top | Inside door channel | 2 | |
| 21 |  | Channel | Channel top/bottom 2405 | Side wall edges | 4 | |
| 22 |  | Channel | Channel bottom 2405 | Roof bottom channel | 2 | |
| 23 |  | Channel | Channel roof 2400 corners mitred | Roof pitch | 2 | |
| 24 |  | L channel | L-channel door opening top 1385 | Front wall atop door channel | 1 | |

Date of checklist completed:..... Personal badge number:..... Signature:.....

In the unlikely event that you find you are missing a part please contact Duroplastic at 0800 766 346 and we will send the missing part directly to your address.

VIEW OF WALL COMPONENTS

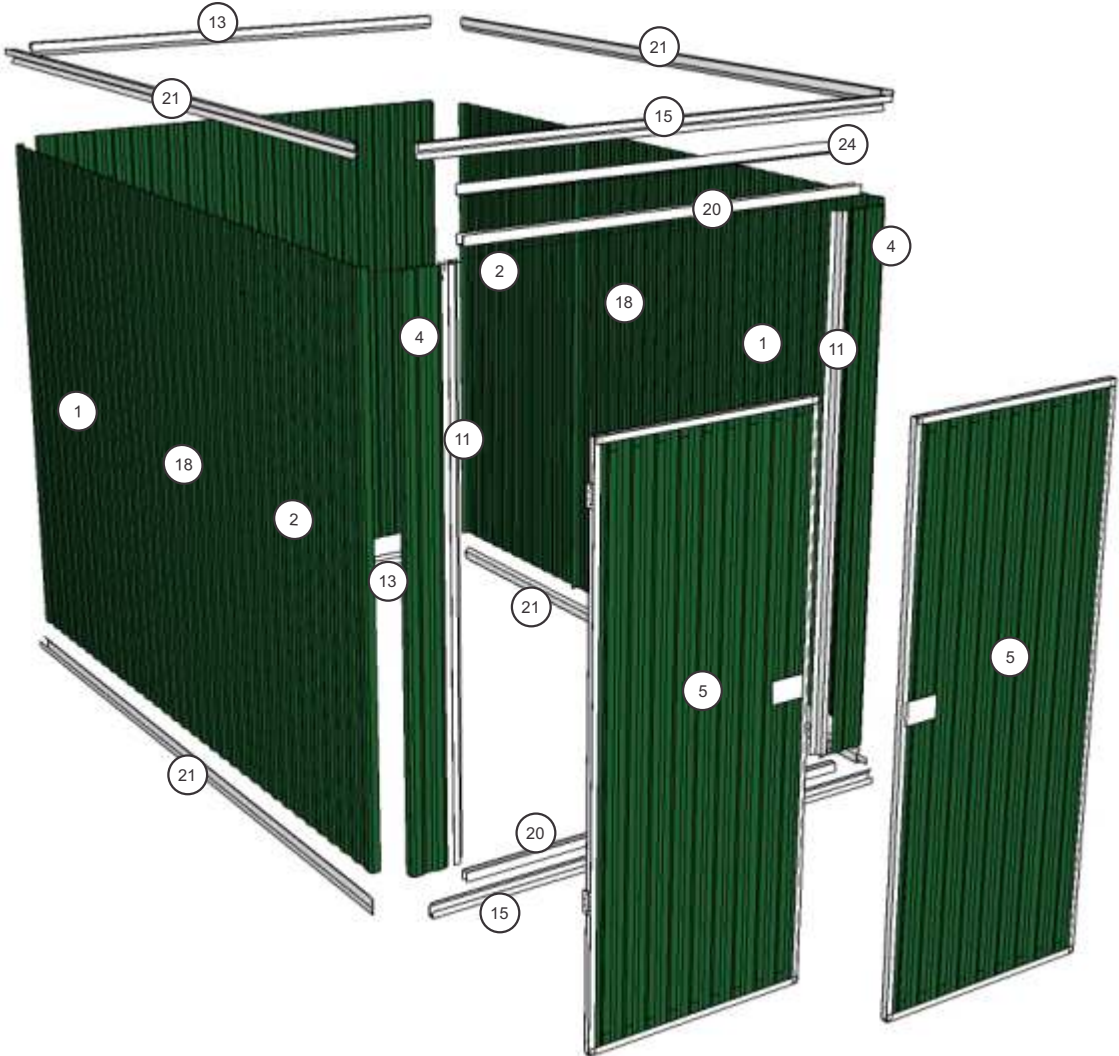

VIEW OF ROOF COMPONENTS

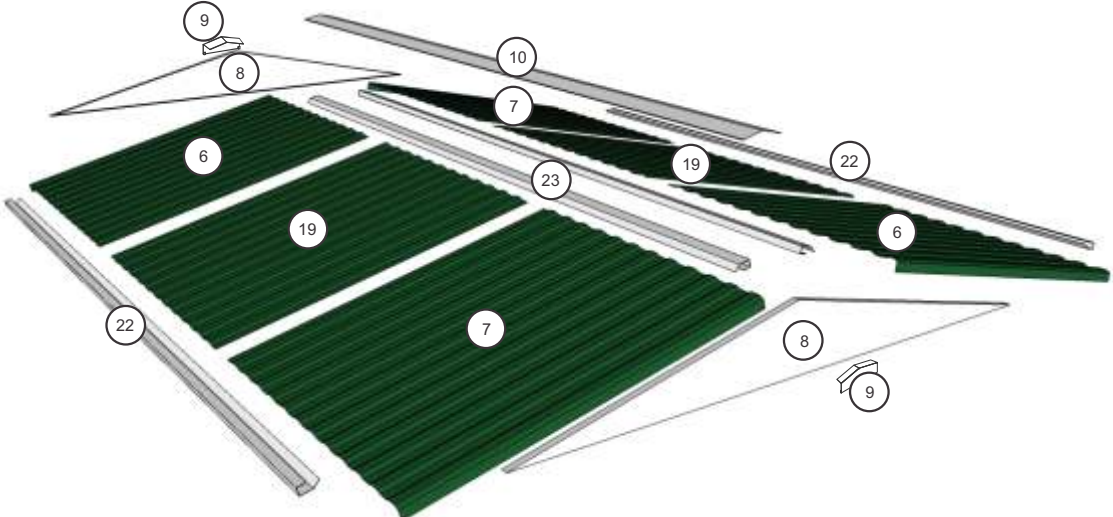

STEP 2: Pre-assemble rear and side wall panels.

You may find it easier to assemble your shed using sawhorses with timber planks attached especially if you are working alone. The planks need to be almost the same length as the shed you have bought or alternatively make use of a trestle table. Be careful when handling your sheets as sharp objects can easily scratch the paint.

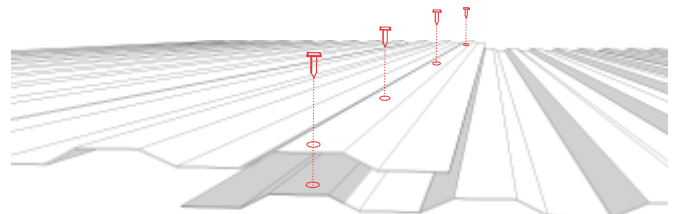

NOTE:

The top and bottom screws to be fixed only after attaching channels.

Overlap sheet 18 (fig2.1) by **two full sheet ridges** over sheet 2. Next overlap sheet 1 (fig2.1) by **one full sheet ridge** over sheet 18 (making sure that the side with pre-drilled holes are atop) on your work table/ground (fig2.2) and join them together with self tapping screws. You will need to make sure the two ends are held firmly together so that the screw penetrates both sheets. Now fit top channel 23 and bottom channel 22 to the sheeting and firmly hold both sheets and channel together and screw into pre-drilled holes.

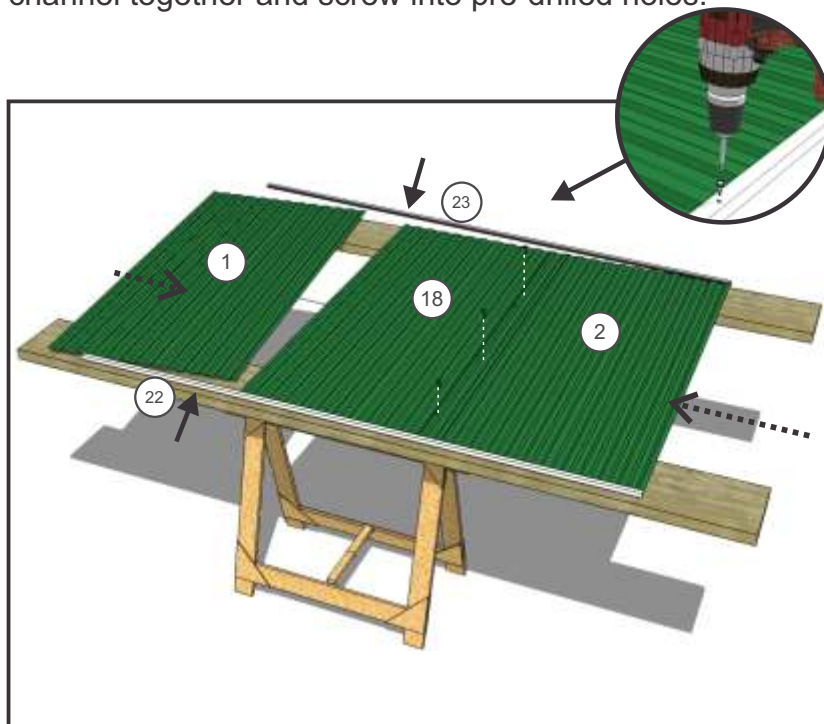

fig2.2

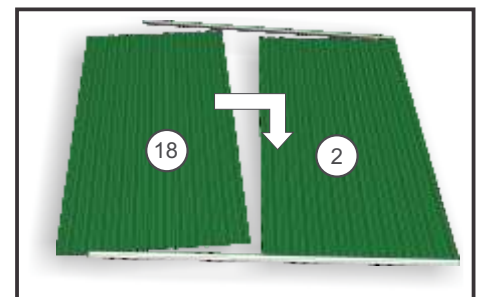

fig2.1

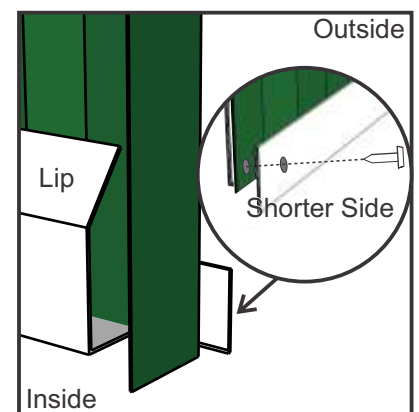

fig2.3

Note that the large inner stiffer lip of the channel is always facing toward the rear-side of the sheet. When the walls are stood upright the lip will be on the interior and you should be looking at the shorter wall of the channel on the outside (fig2.3).

STEP 3: Assemble the front panel and door.

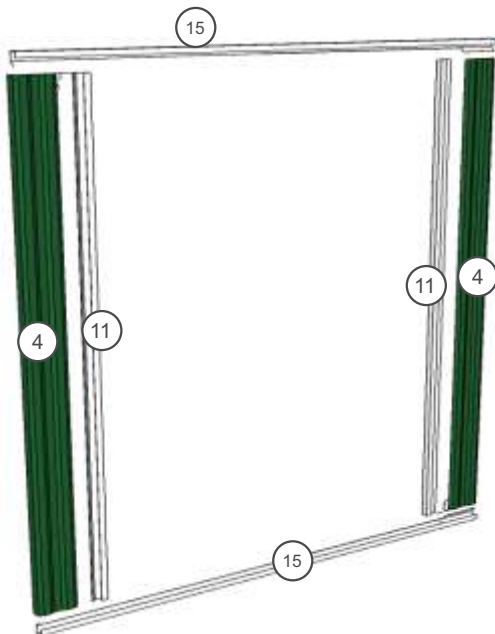

fig3.1

Fit U-channels 11 to wall sheets 4 (do not screw in yet) as per the other walls, but omitting to leave an opening of 695mm where the door is going to be placed (fig3.1).

Now fit channel 15 over channels 11 and sheet 4 (should be a tight fit).

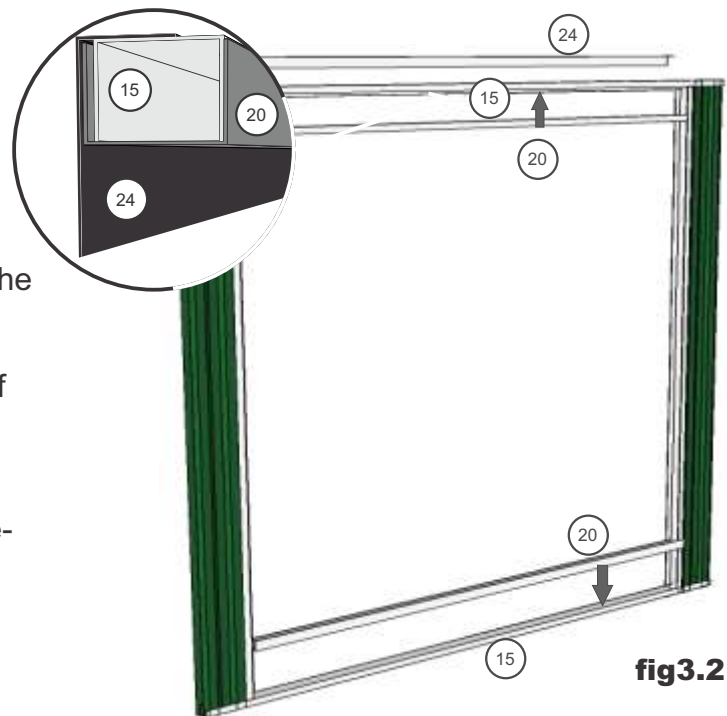

fig3.2

Lastly fit U-channels 20 over 15 where the door space is.

Place L-profile channel 24 at the back of channel 15 (on top).

You may now fix all the channels to the sheets with the wafer screws via the pre-drilled holes.



fig3.3

Now fit your door. If you have your front panel on a table it may be easier to fit it yourself now, as you can line it up while still in a horizontal position. Your hinges have already been attached to the door.

If you wish to hang and fix it vertically you may skip this step and go on to erecting your walls.

When fitting be sure to use a spacer at the bottom and mark any fixings that haven't been pre-drilled beforehand.

STEP 4: Pre-assemble roofpanels

Assemble roof panels in the same manner as walls via stitching the three sheets together. Refer also to p5 for assembly diagram. Attach top and bottom channels 22 and 23 onto the sheets as per wall panels.

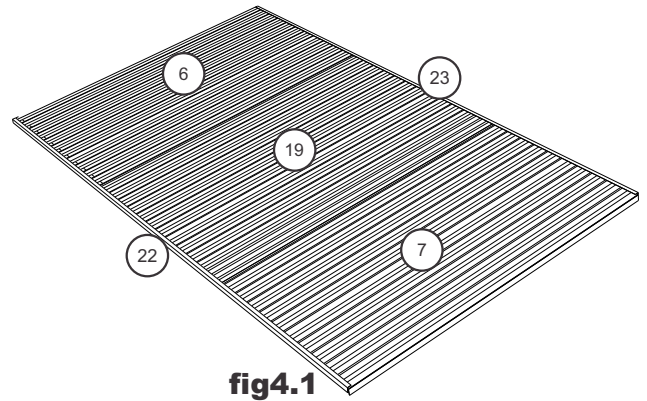

fig4.1

STEP 5: Lay pre-assembled walls and roof out in an open space (fig4.2).

With each panel assembled you should have a layout similar to the below image. See addendum p5 (tear out) for a complete diagram.

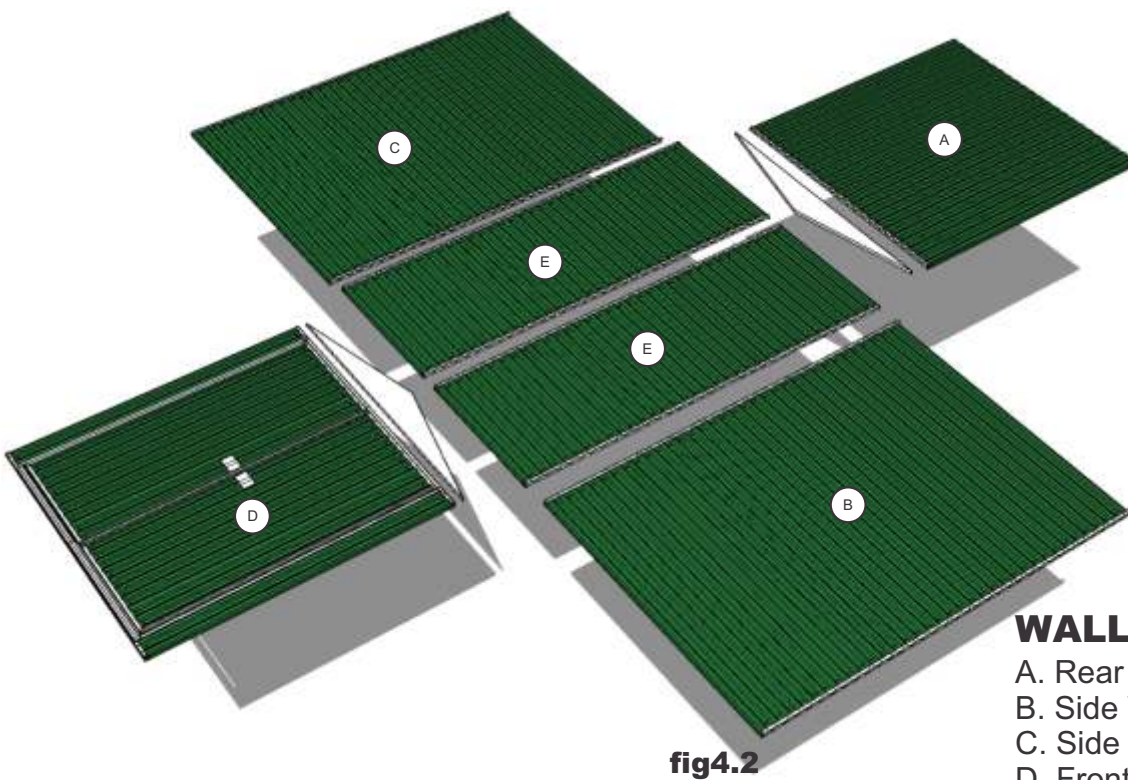
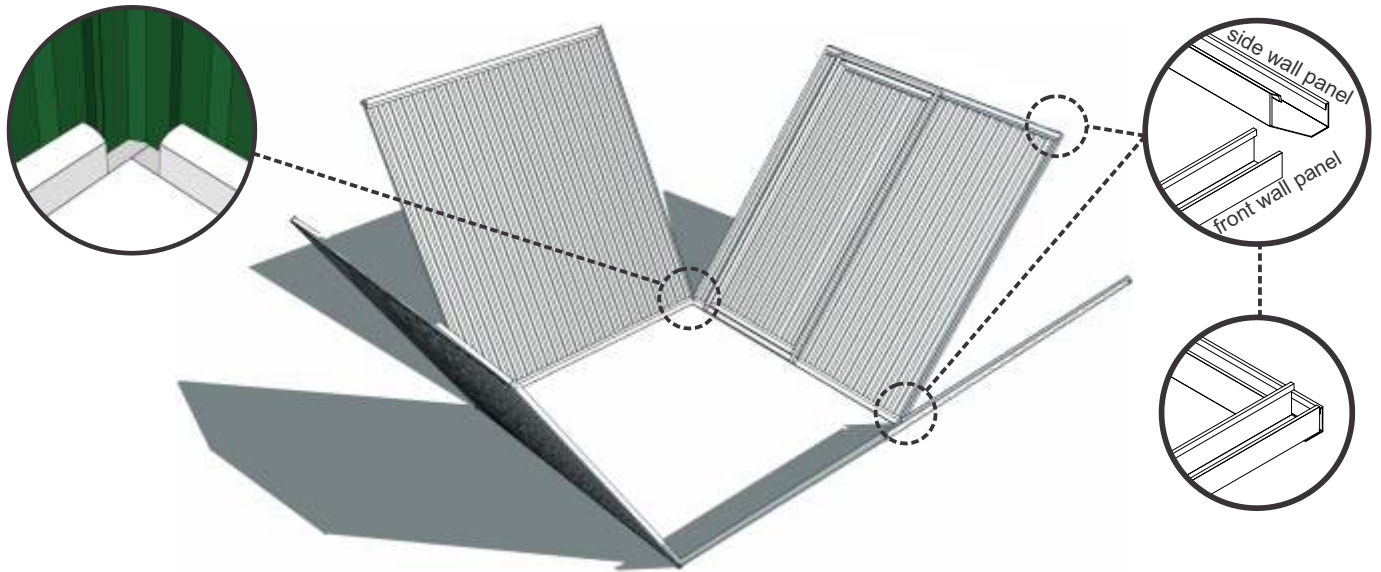

fig4.2

WALL PANEL LIST

- A. Rear Wall
- B. Side Wall 1
- C. Side Wall 2
- D. Front Wall
- E. Roof Panels

STEP 6: Erect the assembled wall panels.



You will require assistance as you set multiple walls upright. Make sure wall panels are the right way around as per fig2.3. With two walls upright fix the adjoining corners together via the self tapping screws provided into pre-drilled holes.

NOTE: the top and bottom screws will secure the channel framework, while the other 3 will stitch the sheets together.

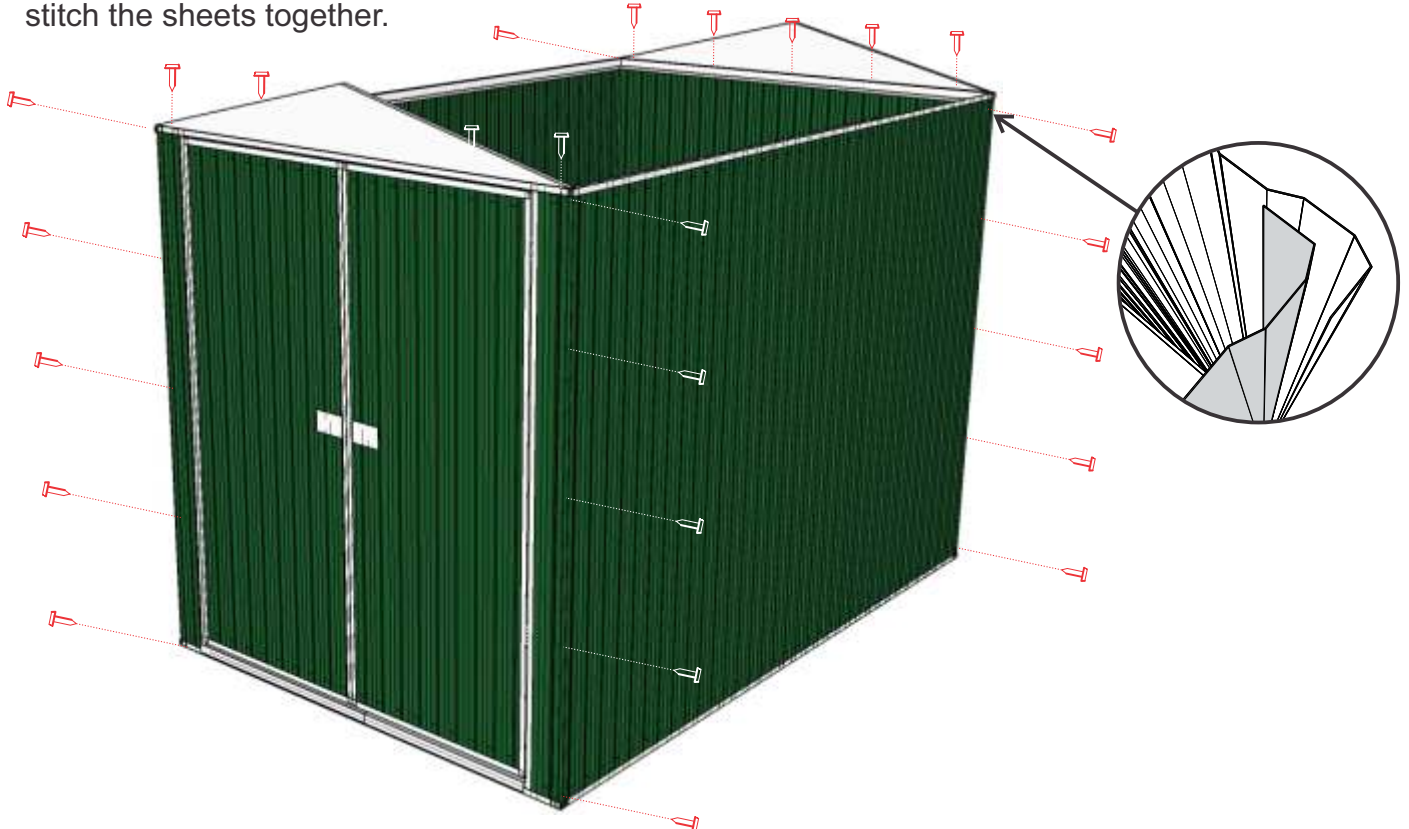

Continue to secure at all four corners. Once the 4 walls are fixed together make sure they are standing level and that they are not skew, but parallel with corners at right angles.

Place the gables on top of front and rear walls and fix from the inside into front and rear wall's upper channel. Gables may also be fixed before walls are erected.

STEP 7: Attach the roof

Assemble roof panels in the same manner as walls via stitching the two sheets together with channeling (a stepladder may make this easier) .

Slide the assembled roof panels into position. fig7.1

Now attached ridge cap (10) and then cover plate (9) to complete the layout.

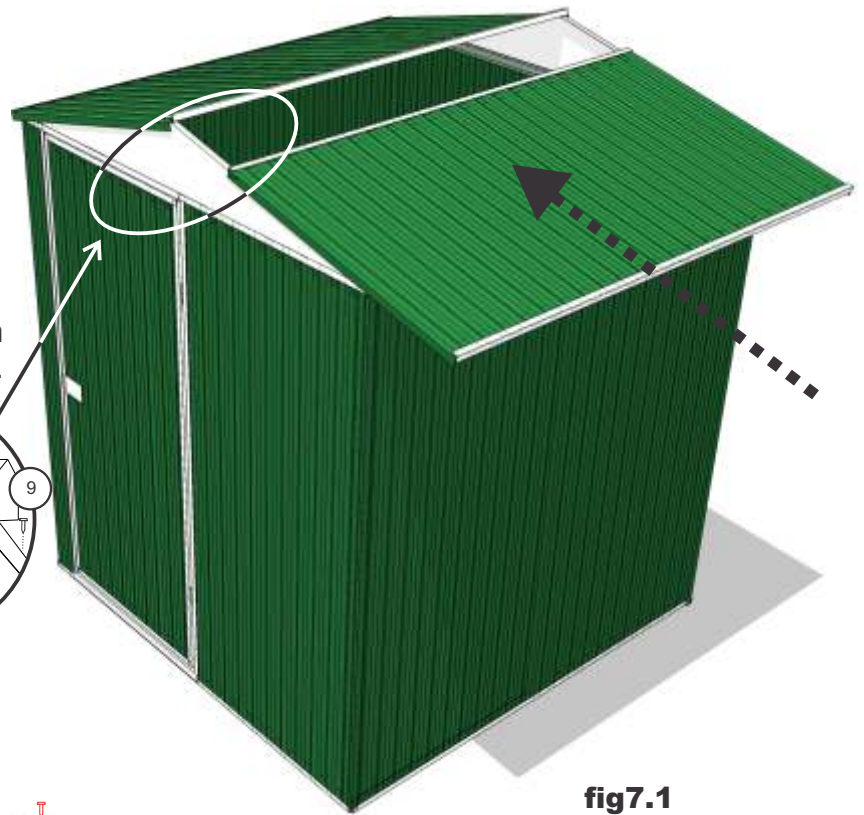
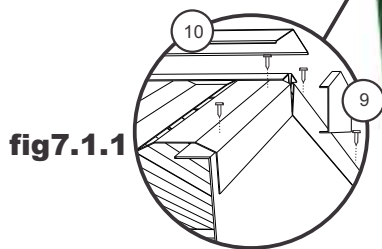

fig7.1



fig7.2

It will rest in place on each side on top of the walls with the lips overhanging the gables fig7.2.

Fix downward through roof sheets (which consists of pre-drilled holes) and into gable lips.

CONGRATULATIONS!
 Your eazished is now fully assembled.

PS: Feel free to add whatever modifications to your shed that you like, possible additions may include: Duolite® Awning • Naturalite® Ecorib/wave polycarb sheets • Multilite® Multiwall • Fibatuf® Fibreglass
As this is a brand new item we welcome any feedback that could help us improve our product!

BASE: It is recommended that your new shed be secured to a concrete slab via an anchor kit as per the specifications below.

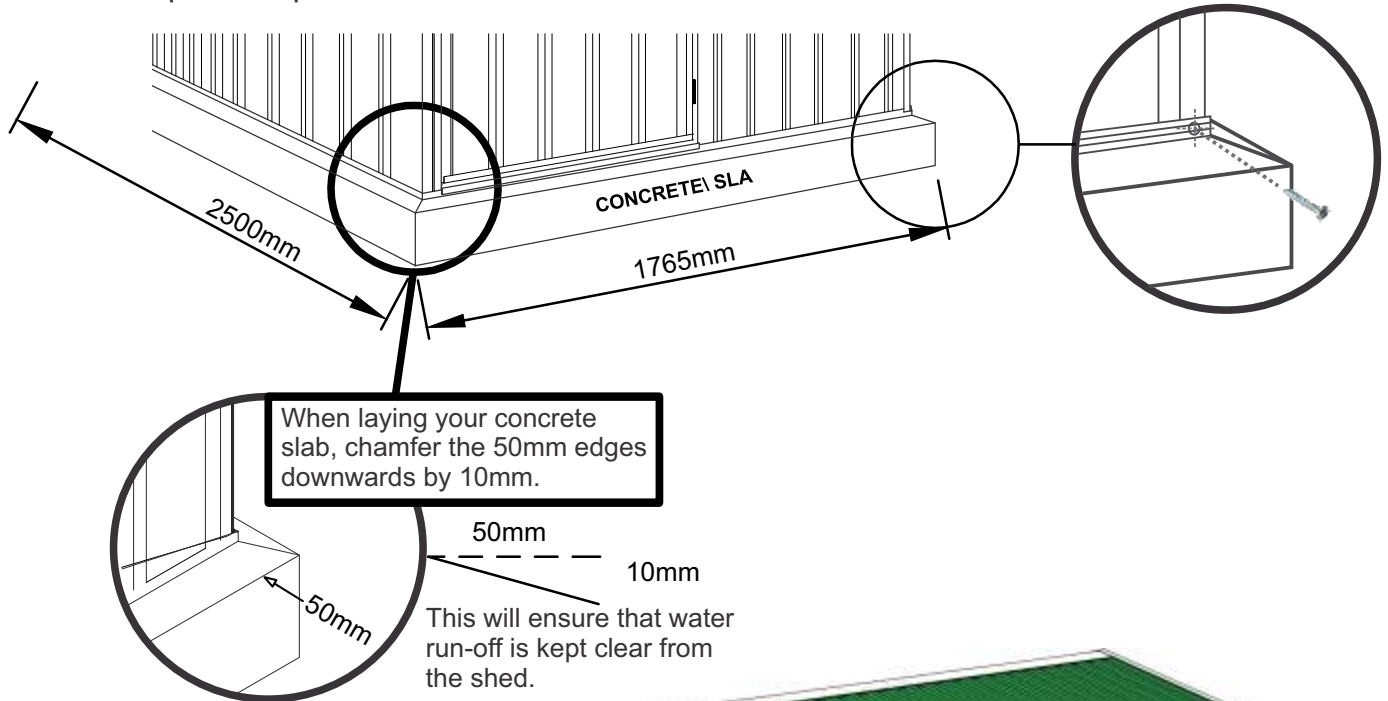

ANCHORING OF SHED

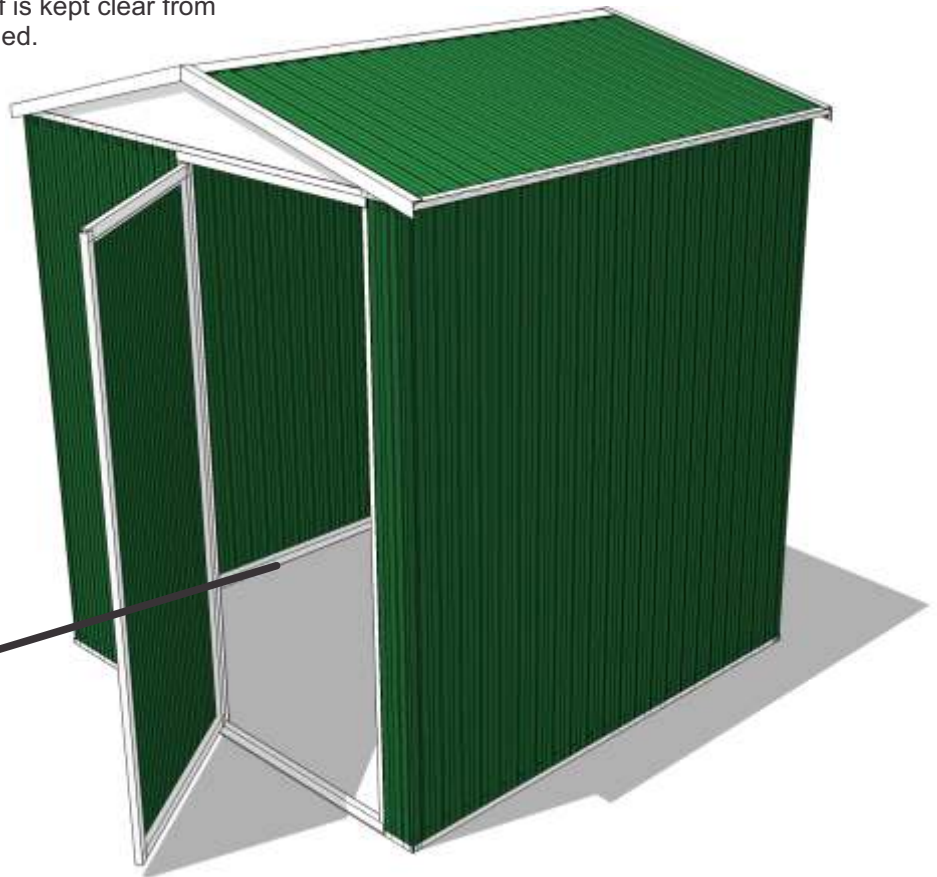
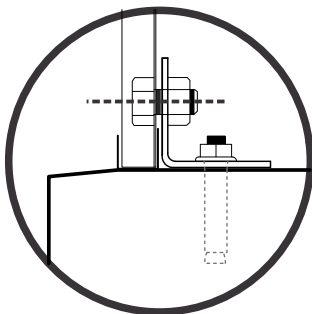
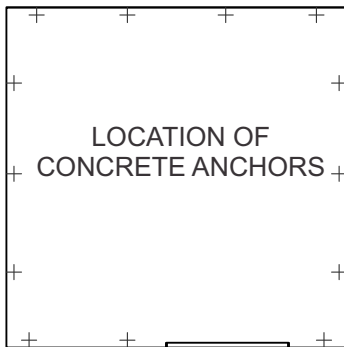

CONCRETE SLAB: Please ensure that your site is level. It is recommended that your slab is 100mm thick and that you use builders plastic with F52 reinforcing mesh. We recommend that you make your slab's perimeter 100mm bigger than the base dimensions of your shed. This will allow for a 50mm edge around your shed. We recommend that you slope these 50mm edges downward by 10mm so that rain water can drain away from your shed.

eazished

For more product information, go to our website:
www.duro.co.za

Head Office, Cape Town: Libra Close, Brackenfell, Tel: 021 982 3427
JHB: Cnr Northway / Marlboro Drive, Kelvin, Sandton Tel 011 804 2804
George: Albert Street, George Industria Tel 044 873 0508
Durban: 22 Trotter Road, Pine Town Tel 031 701 9921

V.1

E&OE 0615

Supplied by
 **DURO**
building the future together