

**1.6M X 1.6M GARDEN SHED
ASSEMBLY INSTRUCTIONS EZ-16161TG**

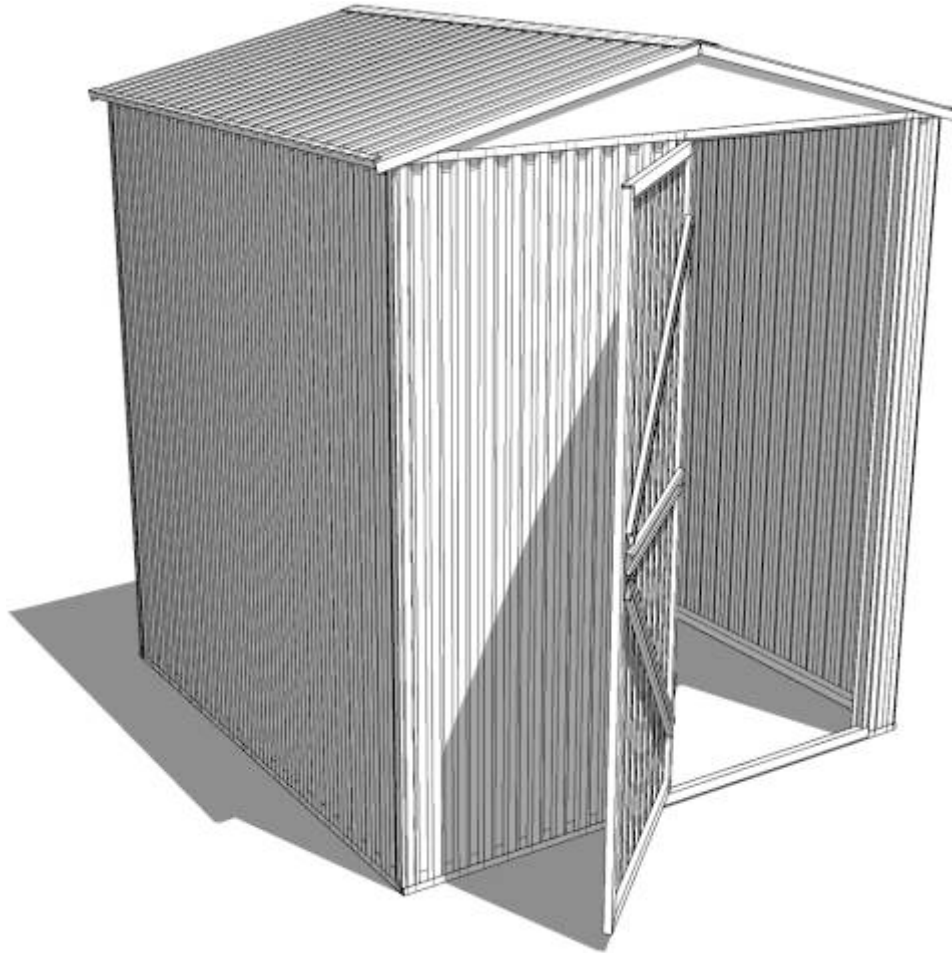

Congratulations on purchasing your new proudly South African **eazished**. Before commencing the assembly, we recommend that you read the instructions thoroughly. Your new shed comes with holes pre drilled to make for fast, easy assembly. We recommend that you assemble the shed using a trestle table or sawhorses and planks. This will ensure that you are working off the ground and make it easier for you. Assembly is a two person job and should not be attempted in windy conditions. Please study this manual carefully and follow the instructions to avoid mistakes.

ASSEMBLY IN 7 EAZI STEPS

- Step 1: Check all parts against the component list
- Step 2: Pre-assemble rear and side wall panels
- Step 3: Pre-assemble front panel & door
- Step 4: Pre-assemble roof
- Step 5: Lay pre-assembled panels out in open space
- Step 6: Erect pre-assembled wall panels
- Step 7: Attach the roof

TOOLS REQUIRED



Spirit Level



Cordless Drill or
one with long lead



Measuring Tape



Pop Rivet Gun



Rubber Mallet



Sturdy Ladder
(two if possible)

OPTIONAL

SITE PREPARATION

Make sure your site is level and free of obstructions.

We recommend anchoring your shed to a 100mm thick cured concrete slab or similar base structure with an anchor kit (see page 11 for base instructions).

A NOTE ON SAFETY

This product will have some sharp edges. We recommend both safety gloves and goggles when handling items and drilling holes.

Ensure shed is securely anchored to base concrete slab once you have completed the build.

A minimum of 2 people are required to erect the shed.



Gloves



Goggles



Saw horse





STEP 1: Check all parts against the component list. Lay out all parts with number facing outwards and check off against parts list.

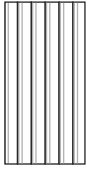
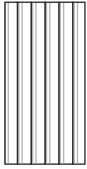

Side / Back Walls Module

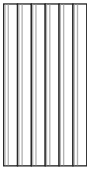
Part No.	Picture	Description	Component	location	QTY	Check
1		Sheet	Sheet 1785x900 left edge bent at right angle with pre-drilled holes	Side / back walls	3	
2		Sheet	Sheet 1785x900 left edge bent at right angle	Side / back walls	3	



Front Wall Module

3		Sheet	Sheet 1785x900 left edge bent at right angle Inner lip bent at 10mm	Front wall	1	
4		Sheet	Sheet 1785x150 right edge bent at right angle Inner lip bent at 10mm	Front wall	1	
5		Sheet	Sheet 1735 x 685 both edges bent at right angle	Front wall DOOR MODULE	1	

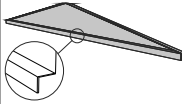



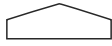

Roof Module

Part No.	Picture	Description	Component	location	QTY	Check
6		Sheet	Sheet 920x900 bent at right angle, edges(rounded) with pre-drilled holes	Roof	2	
7		Sheet	Sheet 920x900 bent at right angle, edges(rounded)	Roof	2	
8		Gable	Sheet 1690 with top edges bent over	Front / rear	2	





Roof Module

Part No.	Picture	Description	Component	location	QTY	Check
9		Cover Plate	Green Gable apex cover	Front / rear	2	
10		Cap	Ridge cap 1660	Roof	1	

Channeling Module

Part No.	Picture	Description	Component	location	QTY	Check
11		Cut U Channel	Door inner 1790 left side	Inside door channel	1	
12		U Channel	Door inner 695 bottom/top	Inside door channel	2	
13		Channel	Channel top/bottom 1665	Wall / roof edges	8	
14		Channel	Channel roof 1665 corners mitred	Roof pitch	2	
15		U Channel	U-channel 1665 bottom/top	Front wall inside door channel	2	
16		Z channel	Z-channel door 1780 right side	Front wall inside door channel	1	
17		L channel	L-channel door opening top 695	Front wall atop door channel	1	

Contents of fastening kit

Picture	Component	Qty	Picture	Component	Qty
	Wafer C2 screws (14x10mm)	140		Pad bolt and keeper	1
	4.8x12mm rivet	10		Ph2 bit	2

Date of checklist completed:..... Personal badge number:..... Signature:.....

In the unlikely event that you find you are missing a part please contact Duroplastic at 0800 766 346 and we will send the missing part directly to your address.

VIEW OF WALL COMPONENTS

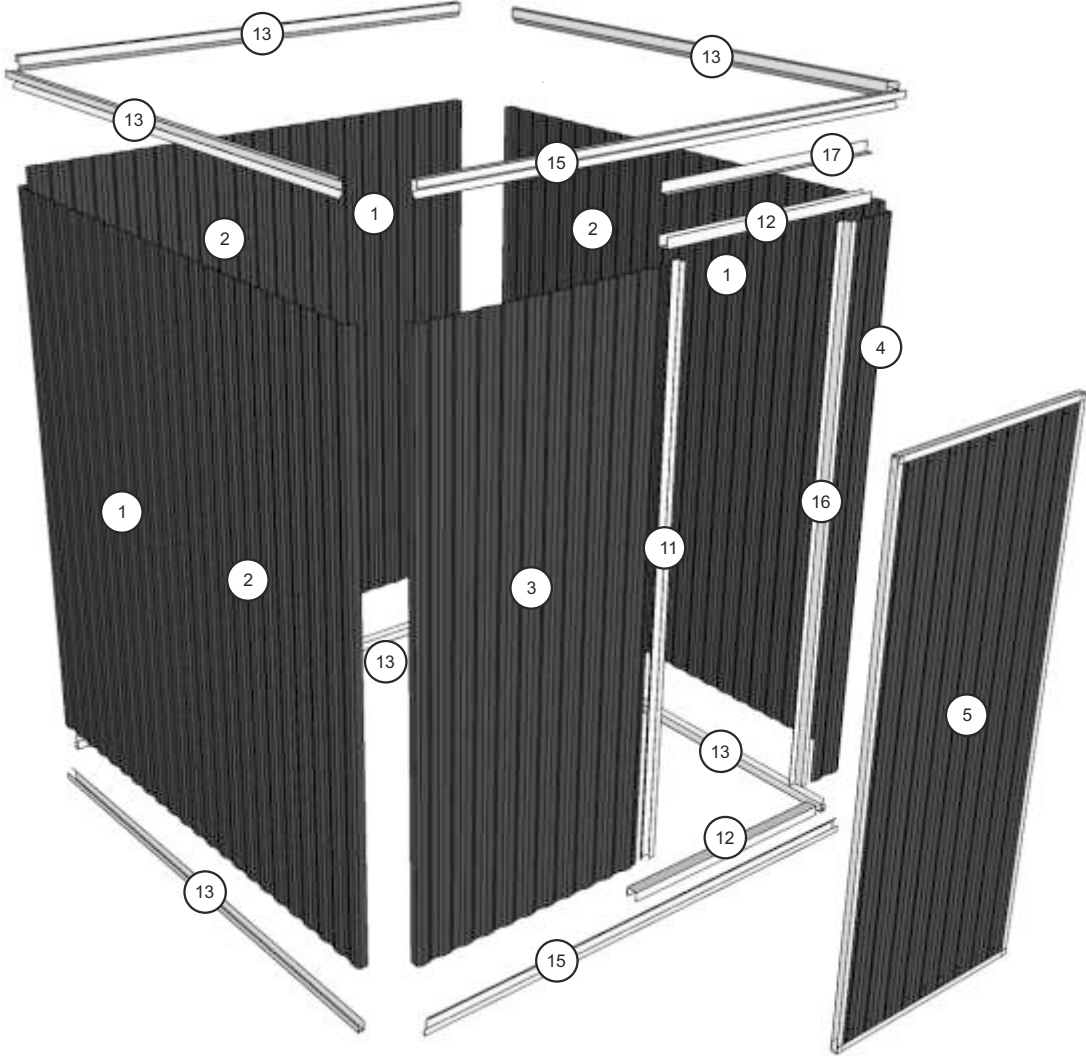

VIEW OF ROOF COMPONENTS

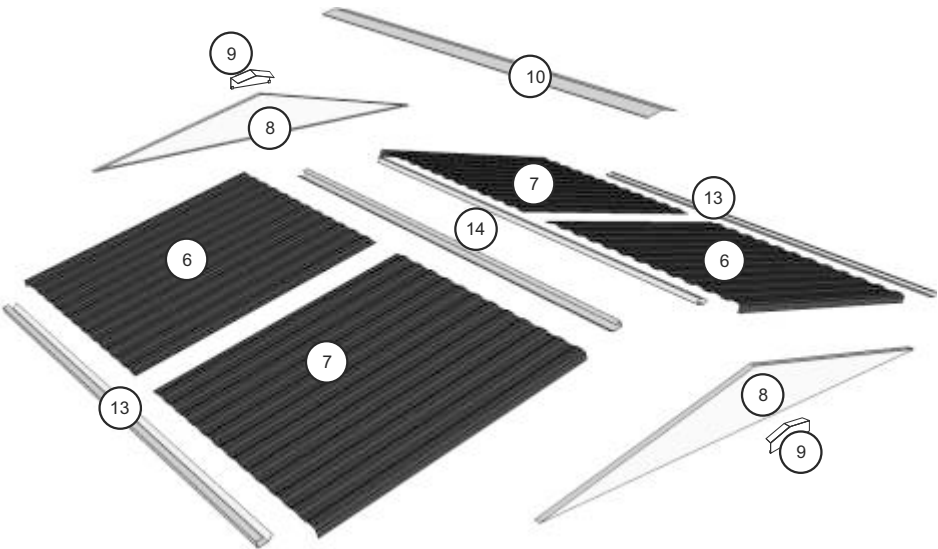

STEP 2: Pre-assemble rear and side wall panels.

You may find it easier to assemble your shed using sawhorses with timber planks attached especially if you are working alone. The planks need to be almost the same length as the shed you have bought or alternatively make use of a trestle table. Be careful when handling your sheets as sharp objects can easily scratch the paint.

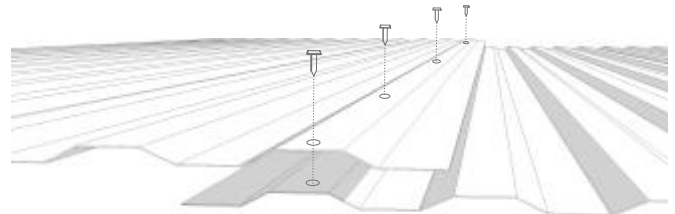

NOTE:

The top and bottom screws to be fixed only after attaching channels.

Overlap two of sheets 1 (fig2.1) by one full sheet ridge (making sure that the side with pre-drilled holes are atop) on your work table/ground (fig2.2) and join them together with self tapping screws. You will need to make sure the two ends are held firmly together so that the screw penetrates both sheets.

Now fit top and bottom channel 11 to the sheeting and firmly hold both sheets and channel together and screw into pre-drilled holes.

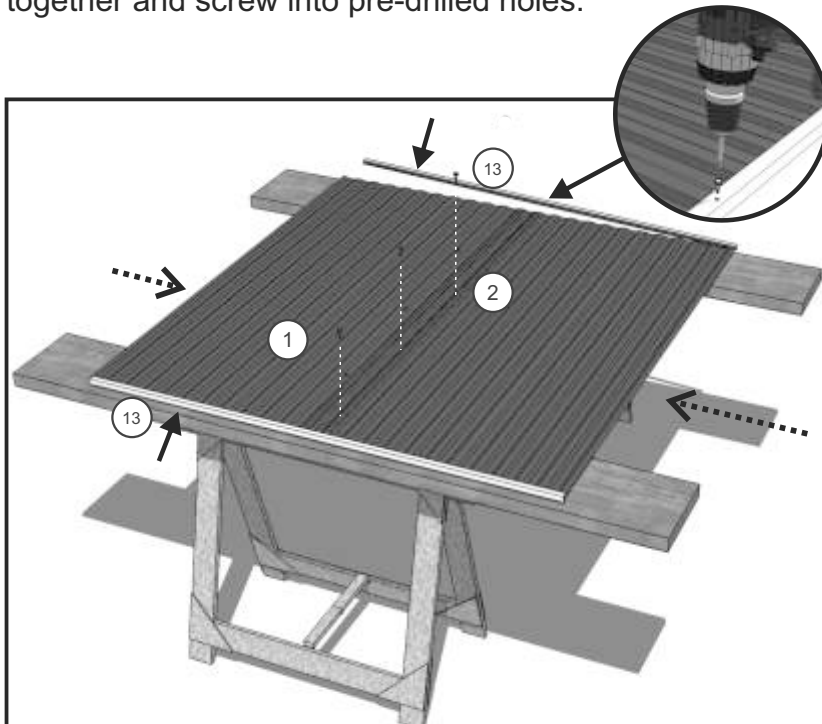

fig2.2

Note that the large inner stiffer lip of the channel is always facing toward the rear-side of the sheet. When the walls are stood upright the lip will be on the interior and you should be looking at the shorter wall of the channel on the outside (fig2.3).

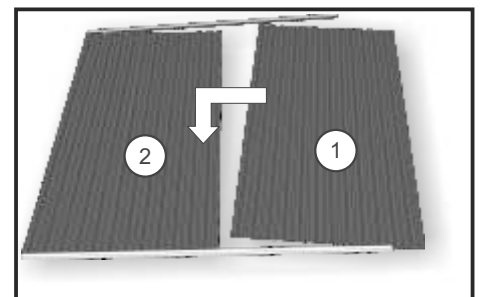

fig2.1

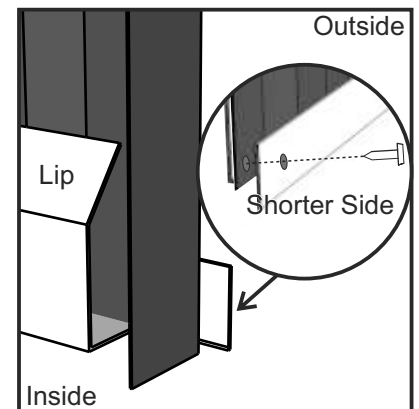

fig2.3

STEP 3: Assemble the front panel and door.

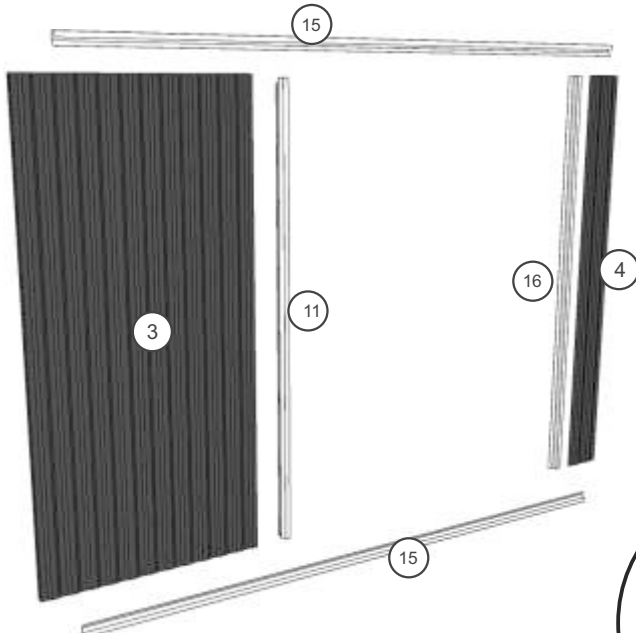

fig3.1

Fit U-channels 15 to wall sheets 4 and 5 (**do not screw in yet**) as per the other walls, but omitting to leave an opening of 695mm where the door is going to be placed (fig3.1).

Now fit channel 11 over channels 15 and sheet 4 (should be a tight fit).

Then fit Z-profile channel 16 over channels 15 and 5 as shown left.

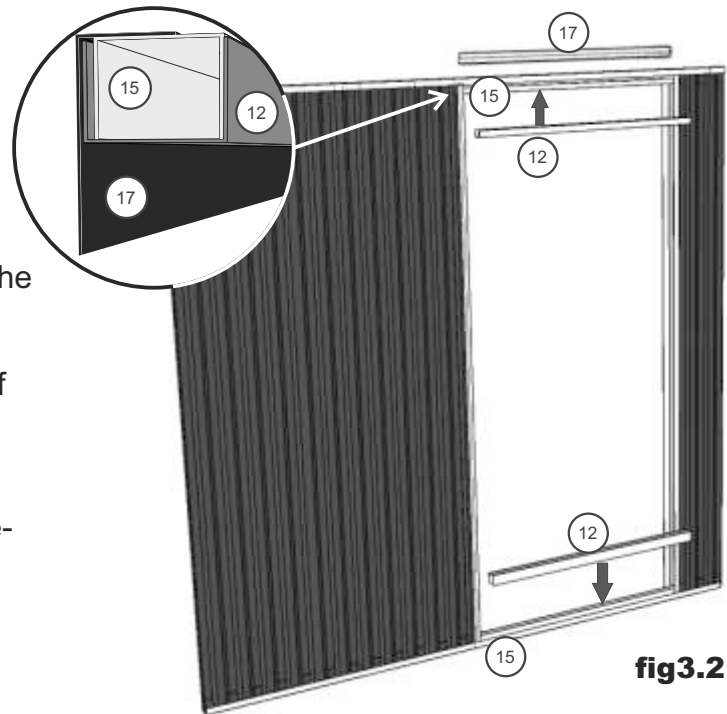

fig3.2

Lastly fit U-channels 12 over 15 where the door space is.

Place L-profile channel 17 at the back of channel 15 (on top).

You may now fix all the channels to the sheets with the wafer screws via the pre-drilled holes.

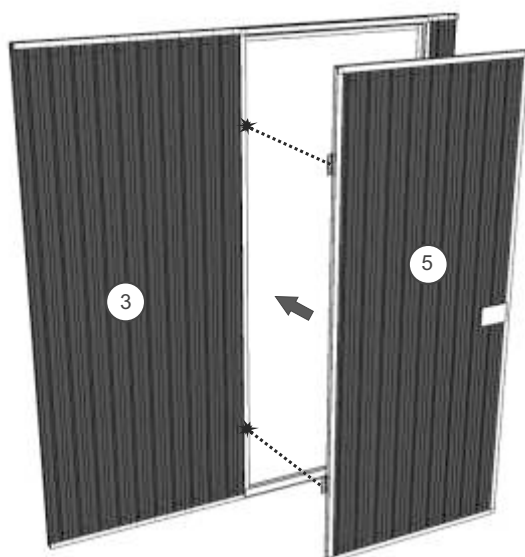

fig3.3

Now fit your door. If you have your front panel on a table it may be easier to fit it yourself now, as you can line it up while still in a horizontal position. Your hinges have already been attached to the door.

If you wish to hang and fix it vertically you may skip this step and go on to erecting your walls.

When fitting be sure to use a spacer at the bottom and mark any fixings that haven't been pre-drilled beforehand.

STEP 4: Pre-assemble roofpanels

Assemble roof panels in the same manner as walls via stitching the two sheets together. Refer also to p5 for assembly diagram. Attach top and bottom channels 13 and 14 onto the sheets as per wall panels.

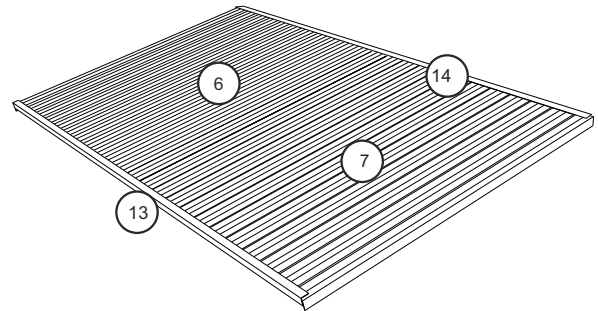
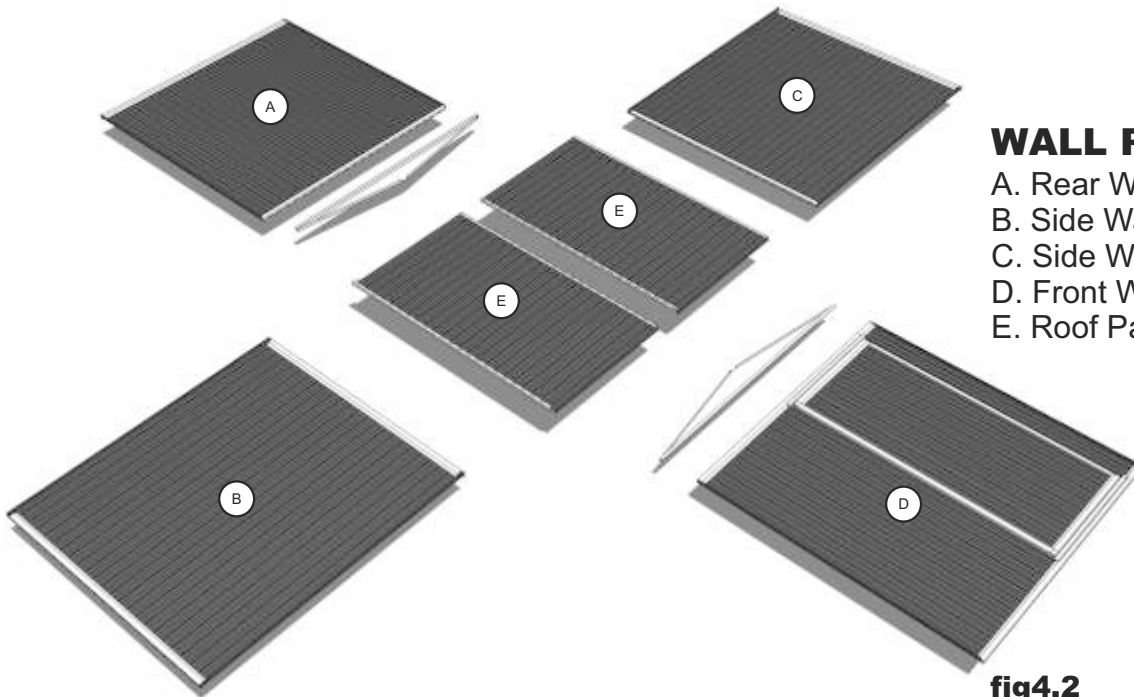

fig4.1

STEP 5: Lay pre-assembled walls and roof out in an open space (fig4.2).

With each panel assembled you should have a layout similar to the below image. See addendum p5 (tear out) for a complete diagram.



WALL PANEL LIST

- A. Rear Wall
- B. Side Wall 1
- C. Side Wall 2
- D. Front Wall
- E. Roof Panels

fig4.2

STEP 6: Erect the assembled wall panels.

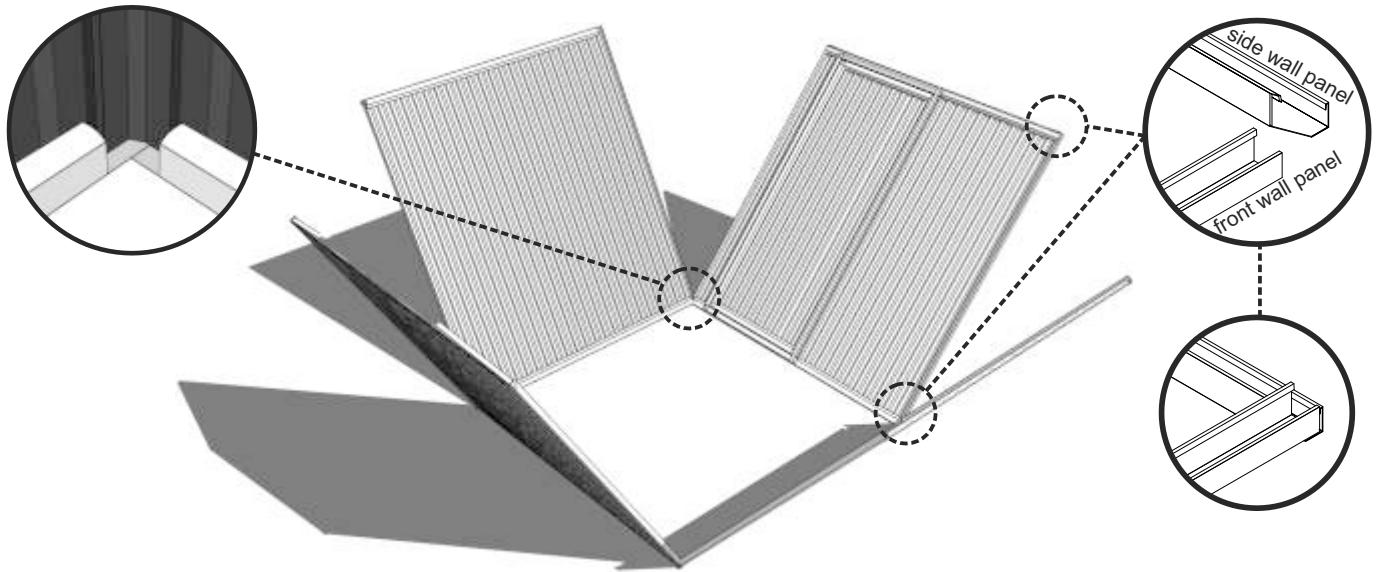

You will require assistance as you set multiple walls upright. Make sure wall panels are the right way around as per fig2.3. With two walls upright fix the adjoining corners together via the self tapping screws provided into pre-drilled holes.

NOTE: the top and bottom screws will secure the channel framework, while the other 3 will stitch the sheets together.

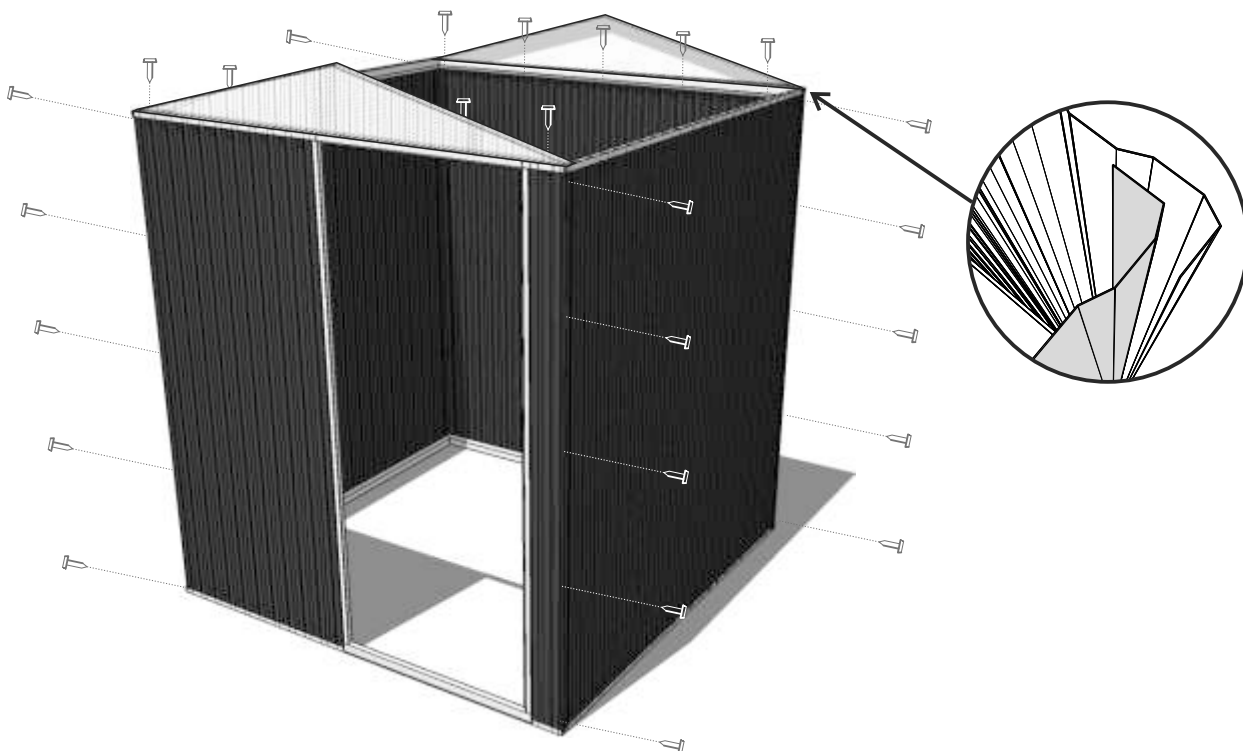

Continue to secure at all four corners. Once the 4 walls are fixed together make sure they are standing level and that they are not skew, but parallel with corners at right angles.

Place the gables on top of front and rear walls and fix from the inside into front and rear wall's upper channel. Gables may also be fixed before walls are erected.

eazished

High Tensile Steel Sheds

Supplied by
DURO
building the future together

STEP 7: Attach the roof

Assemble roof panels in the same manner as walls via stitching the two sheets together with channeling (a stepladder may make this easier) .

Slide the assembled roof panels into position. fig7.1

Now attached ridge cap (10) and then cover plate (9) to complete the layout.

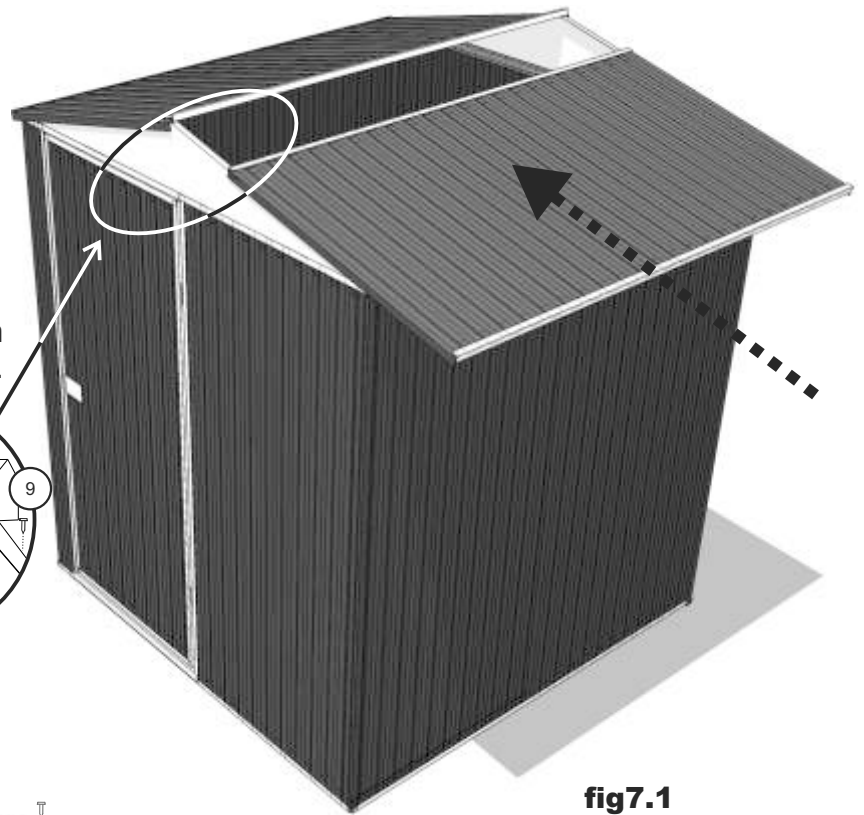
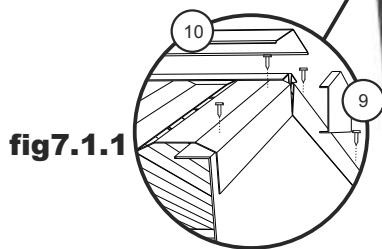

fig7.1

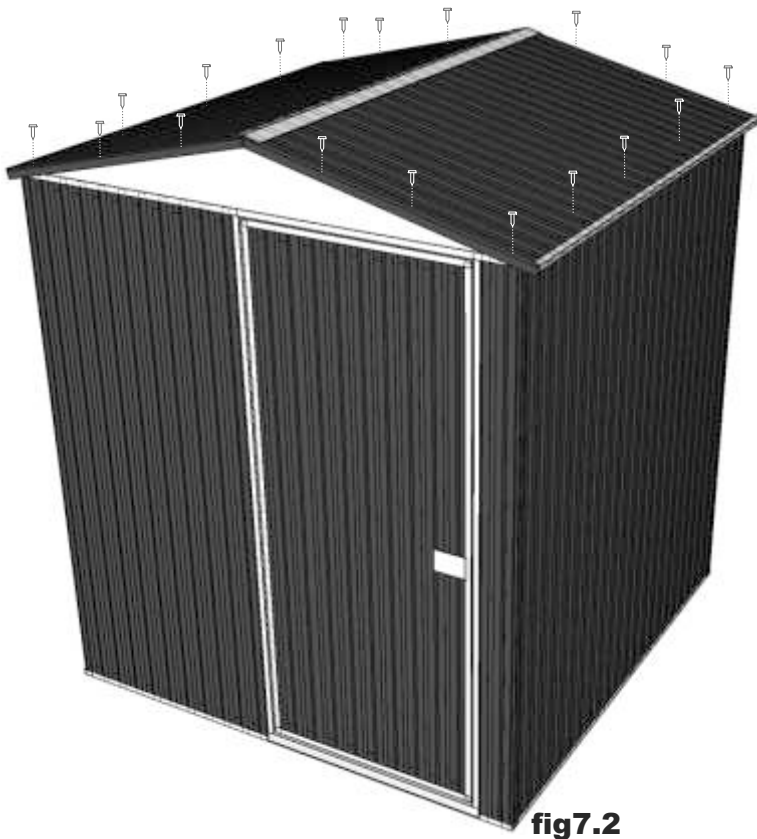

fig7.2

It will rest in place on each side on top of the walls with the lips overhanging the gables fig7.2.

Fix downward through roof sheets (which consists of pre-drilled holes) and into gable lips.

CONGRATULATIONS!
Your eazished is now fully assembled.

PS: Feel free to add whatever modifications to your shed that you like, possible additions may include: Duolite® Awning • Naturalite® Ecorib/wave polycarb sheets • Multilite® Multiwall • Fibatuf® Fibreglass
As this is a brand new item we welcome any feedback that could help us improve our product!

BASE: It is recommended that your new shed be secured to a concrete slab via an anchor kit as per the specifications below.

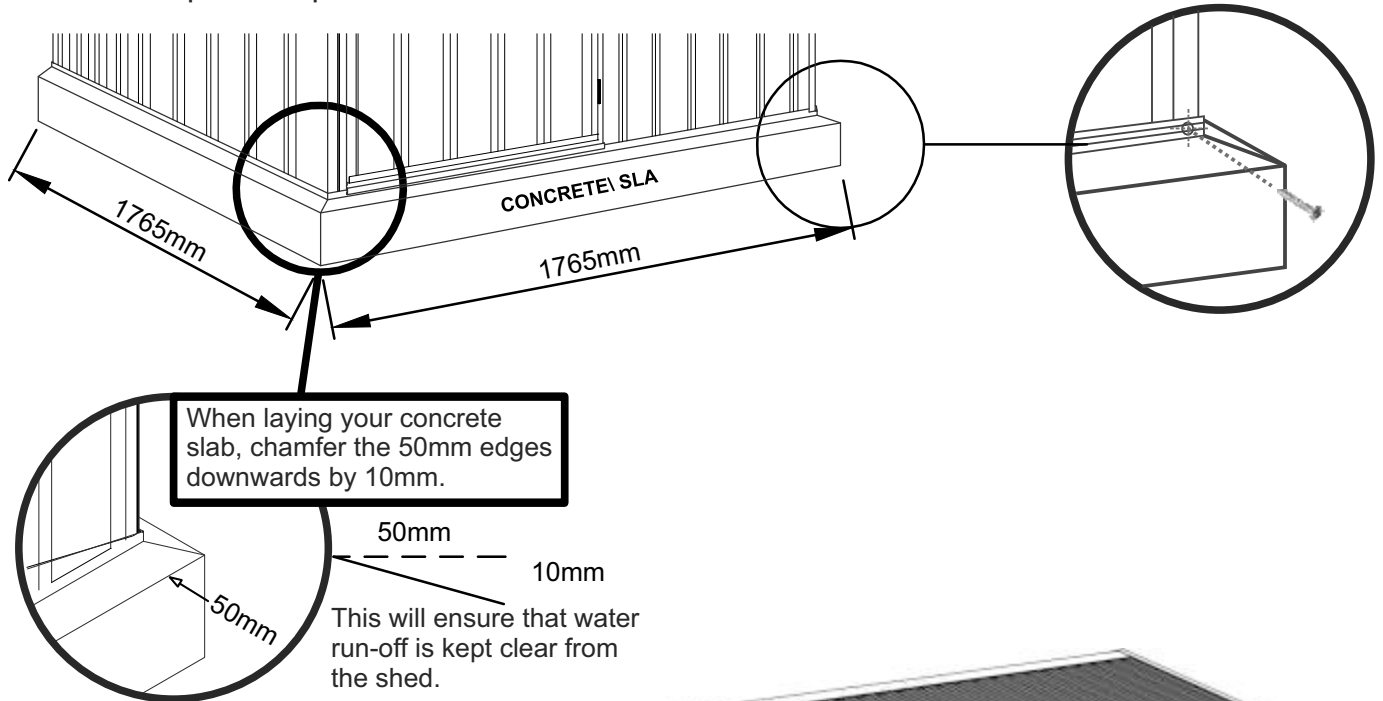

ANCHORING OF SHED

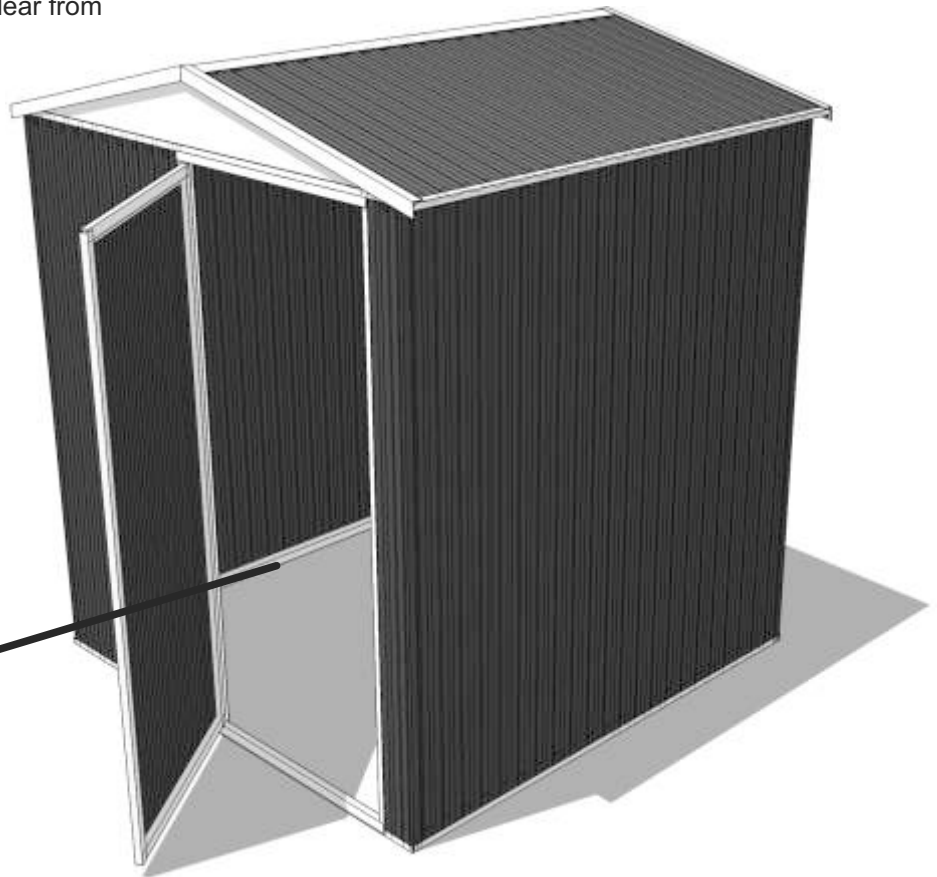
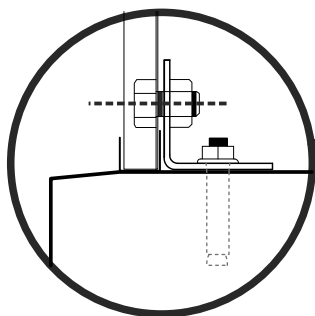
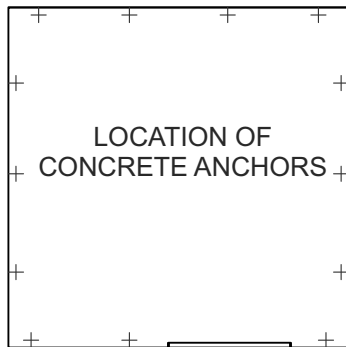

CONCRETE SLAB: Please ensure that your site is level. It is recommended that your slab is 100mm thick and that you use builders plastic with F52 reinforcing mesh. We recommend that you make your slab's perimeter 100mm bigger than the base dimensions of your shed. This will allow for a 50mm edge around your shed. We recommend that you slope these 50mm edges downward by 10mm so that rain water can drain away from your shed.

eazished

For more product information, go to our website:
www.duro.co.za

Head Office, Cape Town: Libra Close, Brackenfell, Tel: 021 982 3427
JHB: Cnr Northway / Marlboro Drive, Kelvin, Sandton Tel 011 804 2804
George: Albert Street, George Industria Tel 044 873 0508
Durban: 22 Trotter Road, Pine Town Tel 031 701 9921

V.5

E&OE 0415

Supplied by
 **DURO**
building the future together